



Diaphragm seal MD 40 for paper and pulp industries



Benefits

- Special flange connection for the pulp and paper industries
- Compact design
- Can be welded directly to the pressure gauge
- Various tubus lengths available

Application

For mounting to Bourdon tube pressure gauges, pressure transducers or pressure switches. For corrosive, highly viscous, polluted or hardening media. Typical application areas:

Paper industry

Pulp industry

Lacquer industry

Versions

	Process connection	Instrument connection	Nominal pressure	Part no.
	DN 48	Welded connection	PN 40	31347W

Blue part no. = in-stock items



Technical specifications

Process connection/tubus

Stainless steel 316 L, DN 48
Loose retaining flange
Stainless steel 304

Diaphragm

Stainless steel 316 L

Seal

NBR (Perbunan)

Instrument connection

Stainless steel 316 L
Welded connection

Pressure transmission liquid

Paraffin oil (FM 09), FDA-listed

Pressure range

See overview of versions

Nominal pressure

PN 40

Scope of delivery

- Diaphragm seal
- Screws M6 x 20 (galvanised steel)
- Seal (NBR) 59 x 48 x 2 mm

Options

Process connection/tubus

- Extended tubus 18 mm (also suitable for O ring seal)
- Special materials
- Silicone-free version

Diaphragm

- Special materials

Instrument connection

- Adapter for instrument connection G $\frac{1}{4}$ B/G $\frac{1}{2}$ B
- Cooling element (> 100 °C)
- Capillary tube

Other

- Other filling liquids

Detail views

Type MD 40

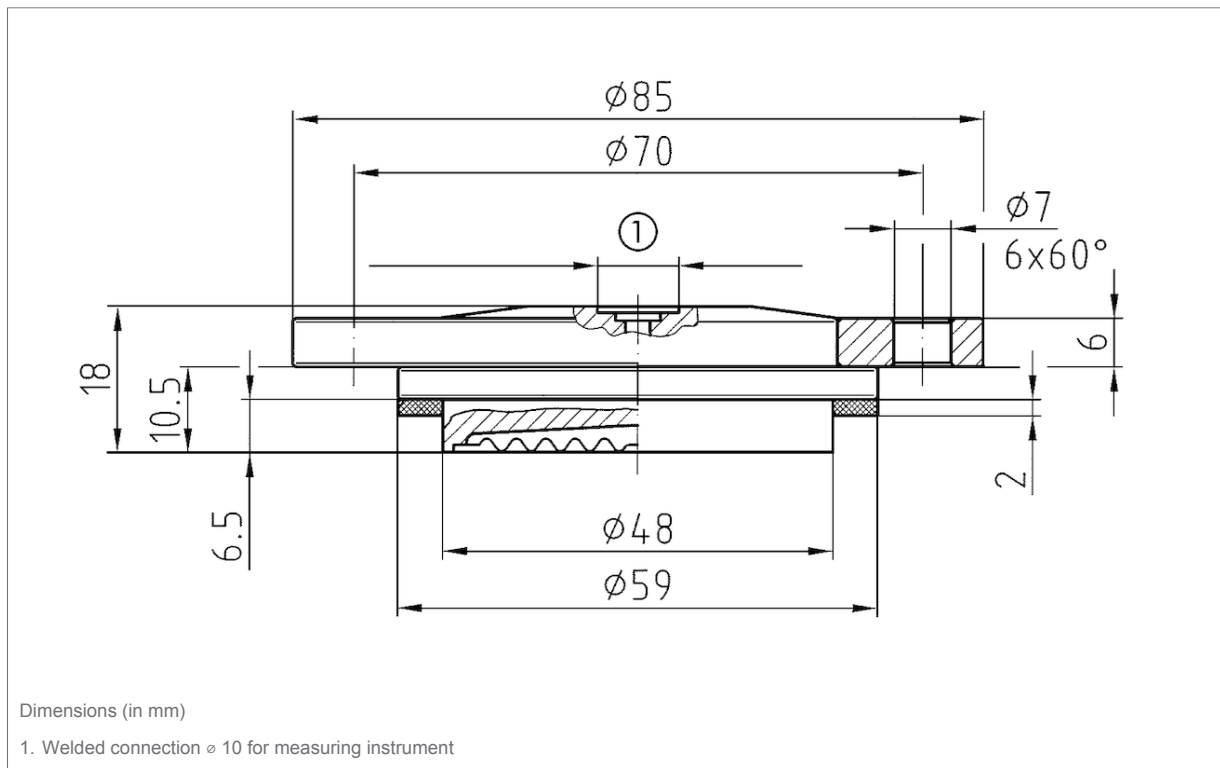



Technical drawings

Type MD 40

