

Combined thermometer/pressure gauge TM



Benefits

- Pressure and temperature measurement with at a single measuring point
- With self-sealing connection thread for fast installation
- Bottom connection or back connection
- With mounting valve for easy replacement without downtime

Application

For liquid media which are not highly viscous, do not crystallise and do not attack copper alloys. For combined measurement of pressure and temperature, especially in heating systems and heating boilers.

Description

The combined thermometer/pressure gauge / thermo-hydrometer consists of a Bourdon tube measuring system for pressure measurement and a bimetal measuring system for simultaneous temperature measurement. Both values are measured and displayed by a single gauge. A self-closing mounting valve enable easy replacement of the measuring instrument without requiring the system to be drained. An optional M18 x 1 to G $\frac{1}{4}$ adapter is available if the combined thermometer/pressure gauge has to be mounted into an existing thermowell with M18 x 1 female thread.

Technical specifications

Type

D1, D2

Nominal size

63 – 80

Accuracy class

Pressure gauges: 2,5 (EN 837-1/6)

Range

Pressure: 0/4 bar 0/6 bar 0/10 bar

Temperature: 20/120 °C

Application area

Pressure

Static load: $\frac{1}{4}$ x full scale value

Dynamic load: $\frac{1}{3}$ x full scale value

Short-term: Full scale value

Temperature: Full scale value

Operating temperature range

Medium: Max. 120 °C

Ambient: -20/+60 °C

Temperature performance

Pressure: Indication error when the temperature of the measuring system deviates from the normal temperature of 20 °C:

Pressure: at rising temperature approx. ± 0.4 %/10 K

Pressure: falling temperature approx. ± 0.4 %/10 K

Pressure: of full scale value

Degree of protection

IP 32 (EN 60529)

Standard version

Connection

Brass, centre back or bottom
 G $\frac{1}{4}$ B with mounting valve G $\frac{1}{4}$ to R $\frac{1}{2}$
 G $\frac{1}{4}$ B with mounting valve G $\frac{1}{4}$ to R $\frac{1}{2}$, Adapter G $\frac{1}{4}$ to M 18 x 1

Measuring element

Pressure: Bourdon tube, Copper alloy
 Temperature: Bimetal spiral

Dial

Plastic, white
 Scaling black with red/blue circular arcs

Pointer

Pressure: Plastic, black
 Temperature: Plastic, Red

Housing

D1: Plastic
 D2: Sheet steel, black

Window

Plastic, clipped in with adjustable red mark

Options

- Adapter M 18 x 1 to G $\frac{1}{4}$
- Special scales
- Other process connections

Detail views

Mounting valve and adapter

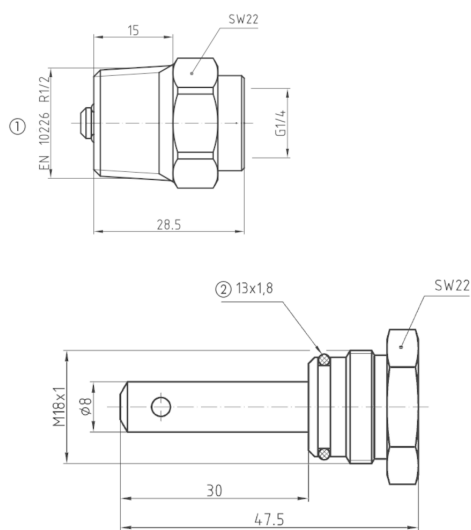

Dimensions (in mm)

1. Pipe thread
2. O ring (NBR)

TM 80 ax

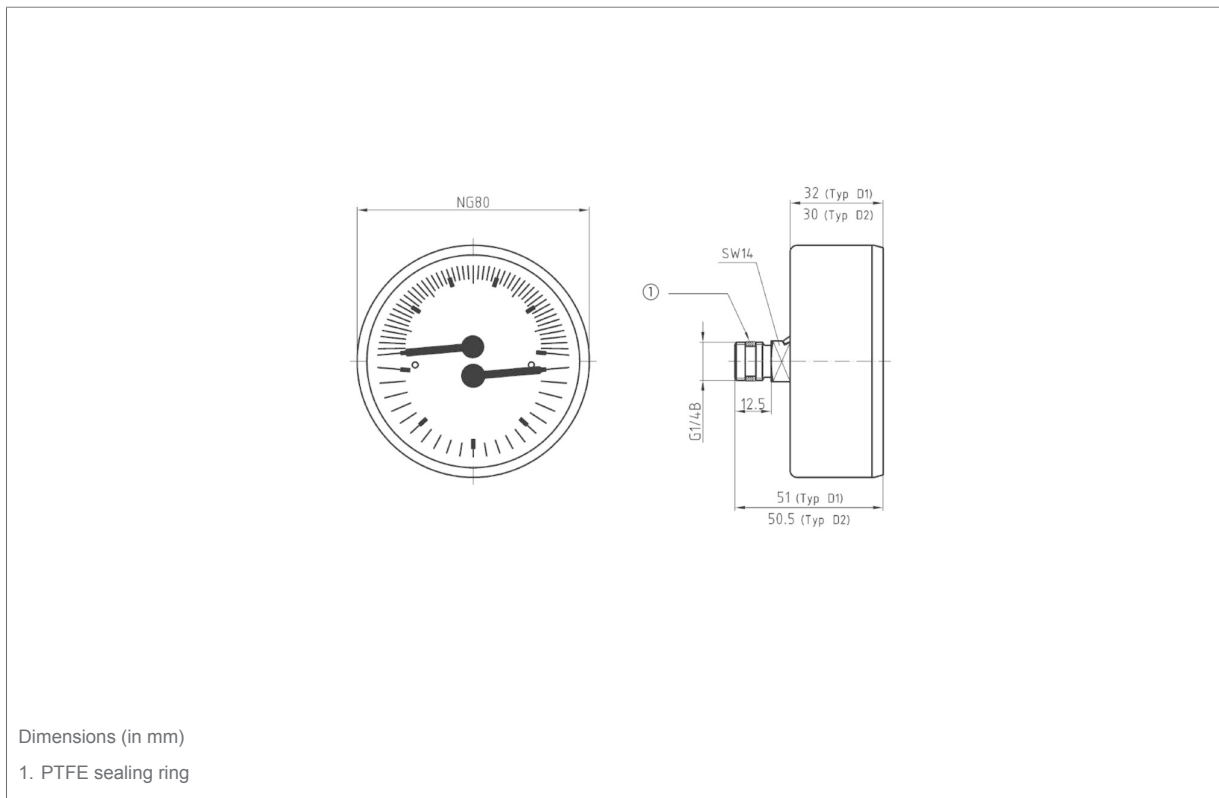

TM 63 ax with mounting valve

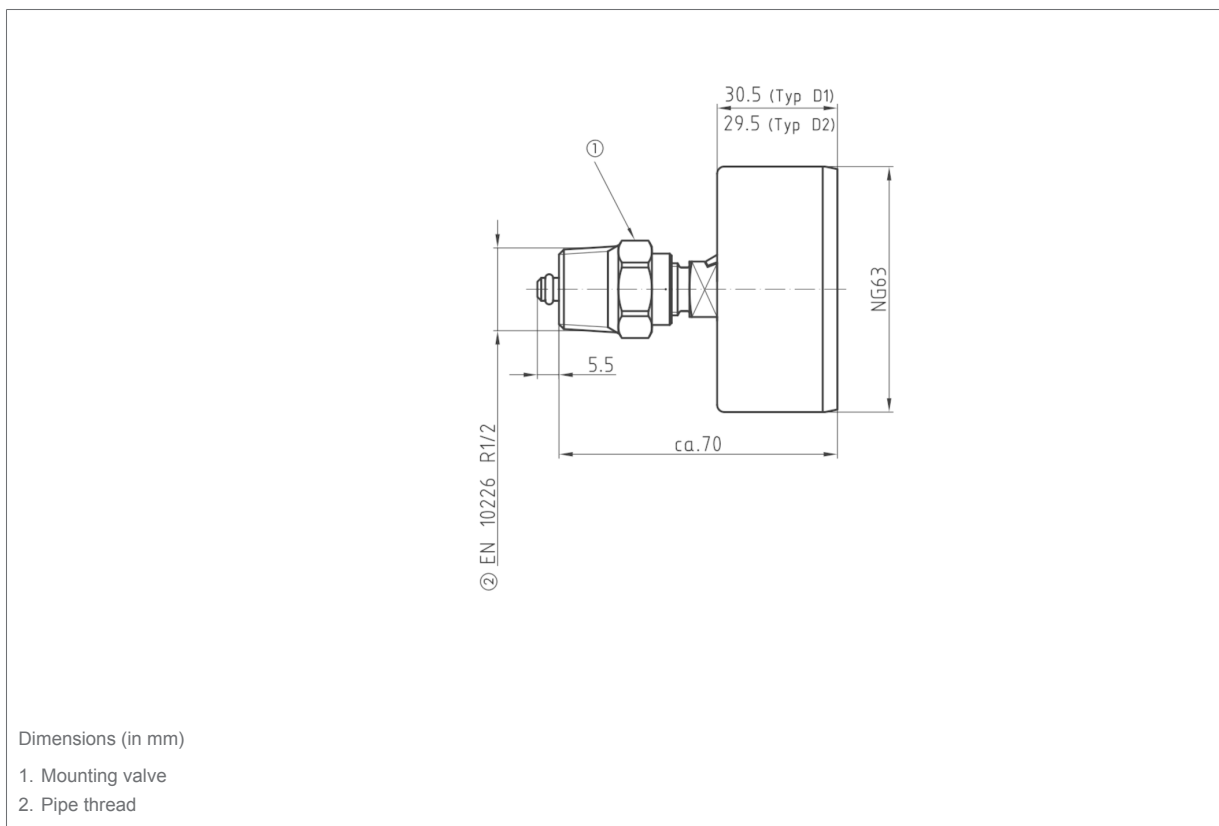

TM 63 ax

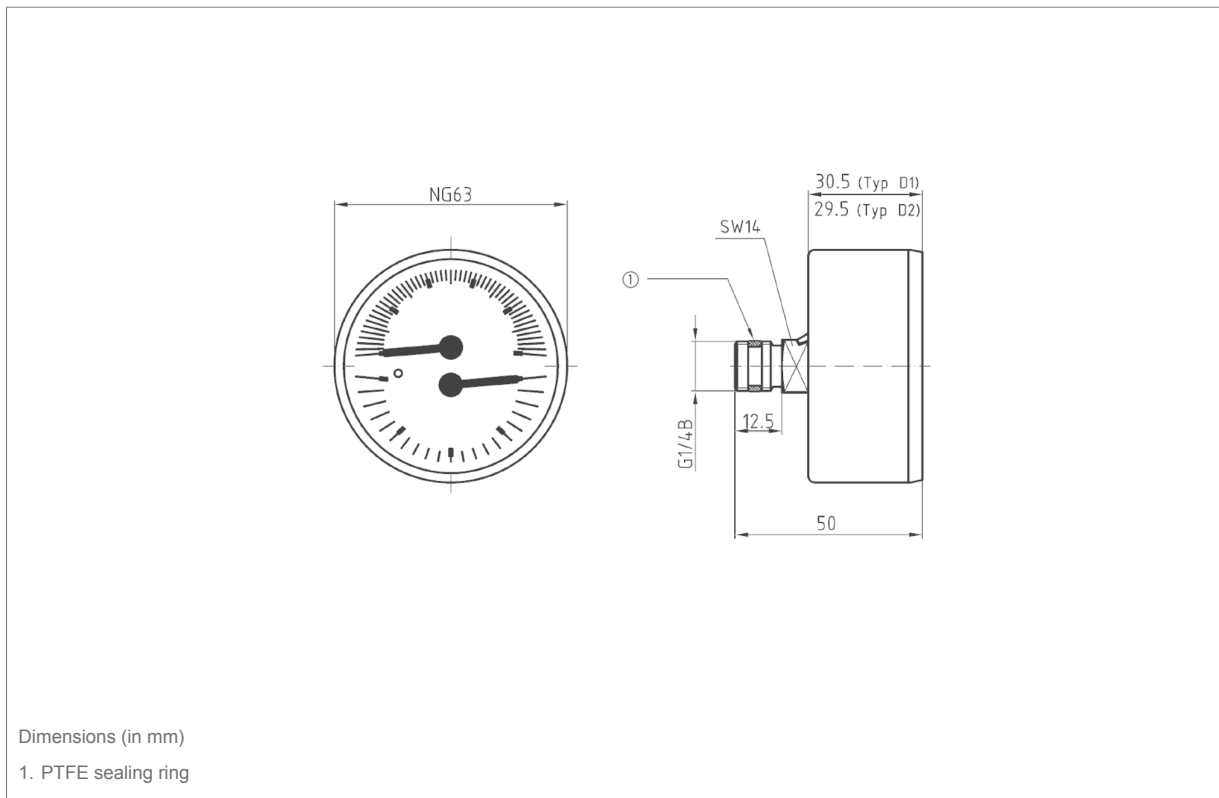

TM 80 rad

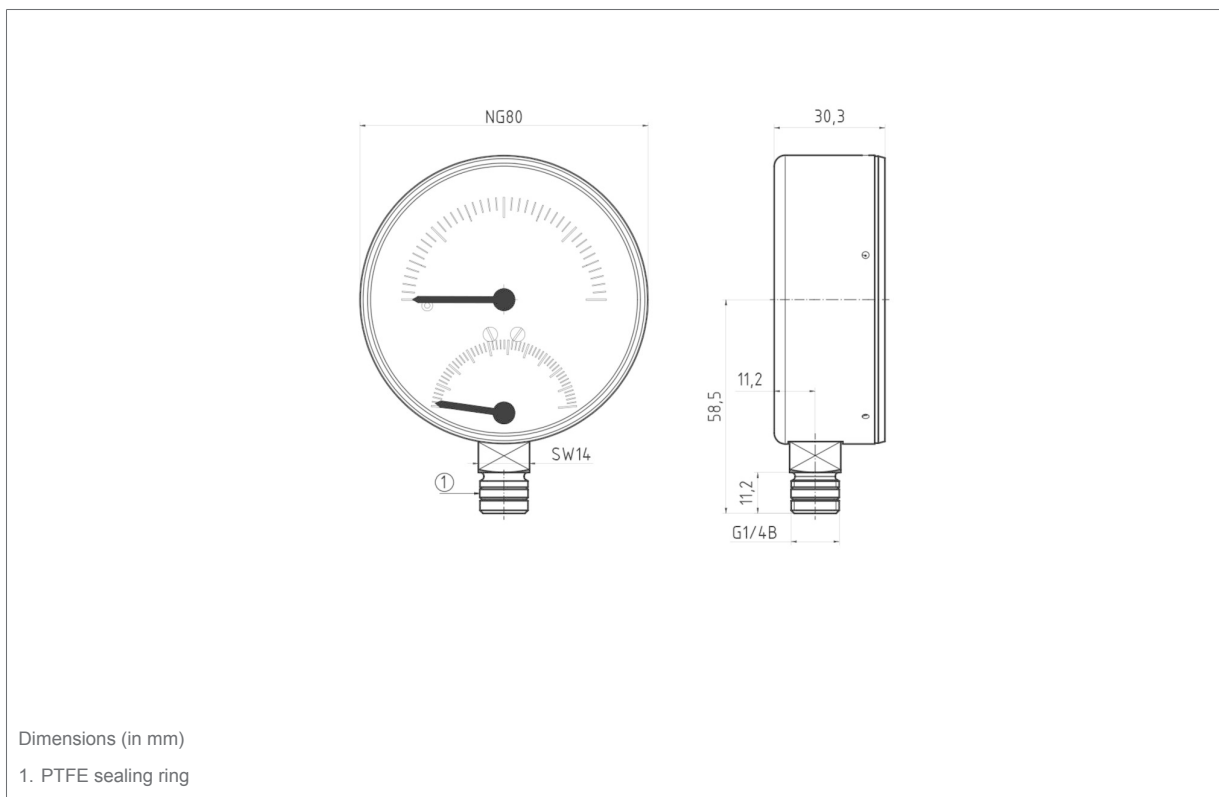

TM 80 ax with mounting valve

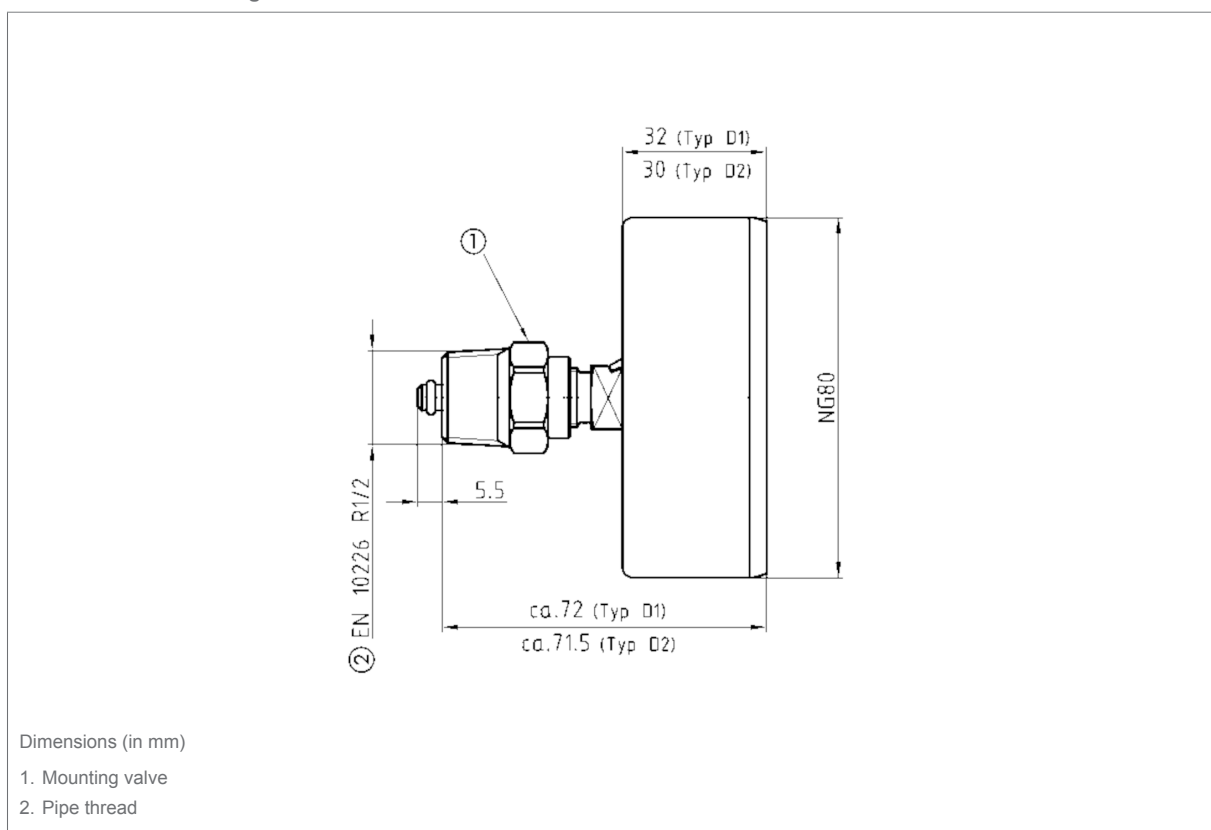

Technical drawings

Mounting valve and adapter

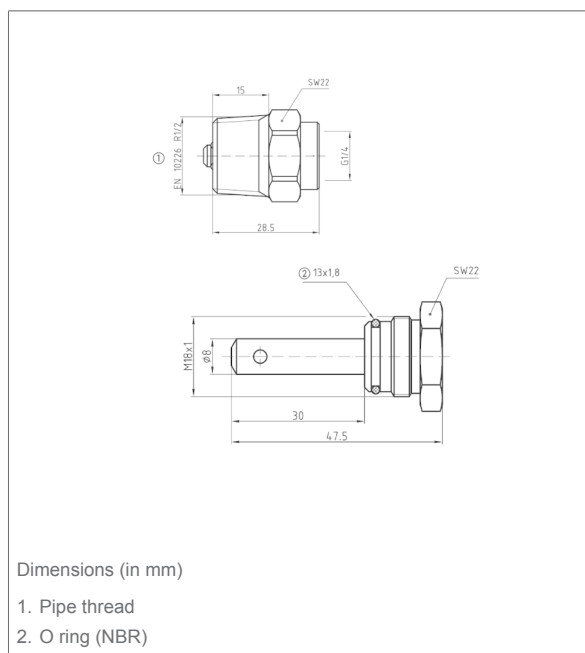

TM 80 ax

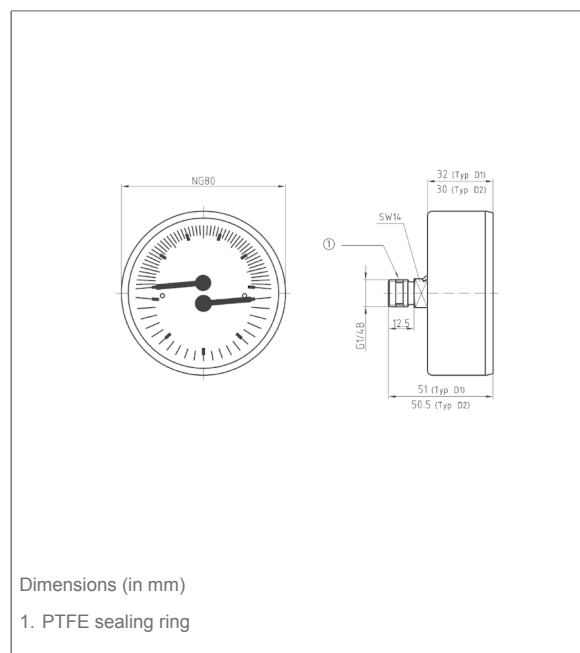

TM 63 ax with mounting valve

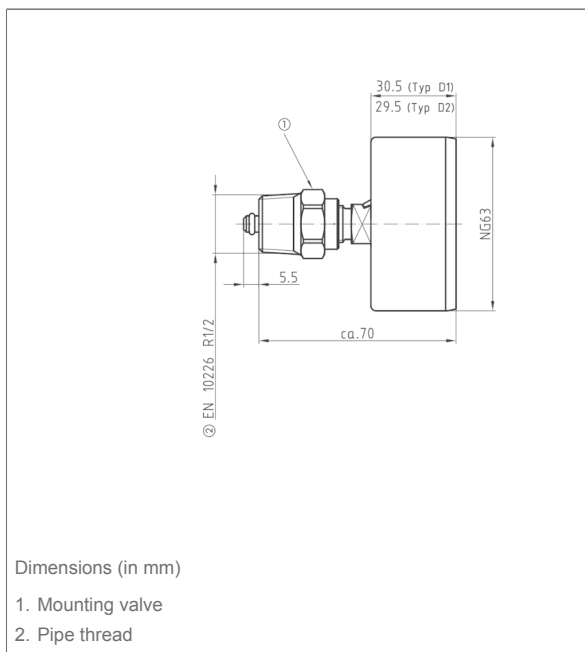

TM 63 ax

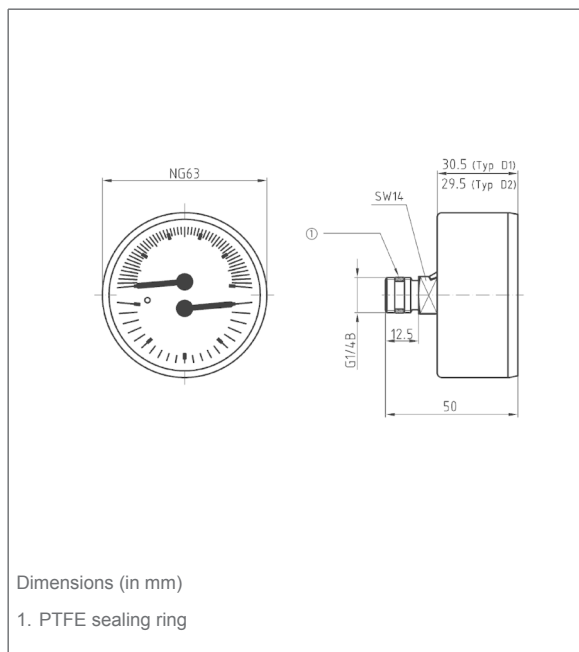

TM 80 rad

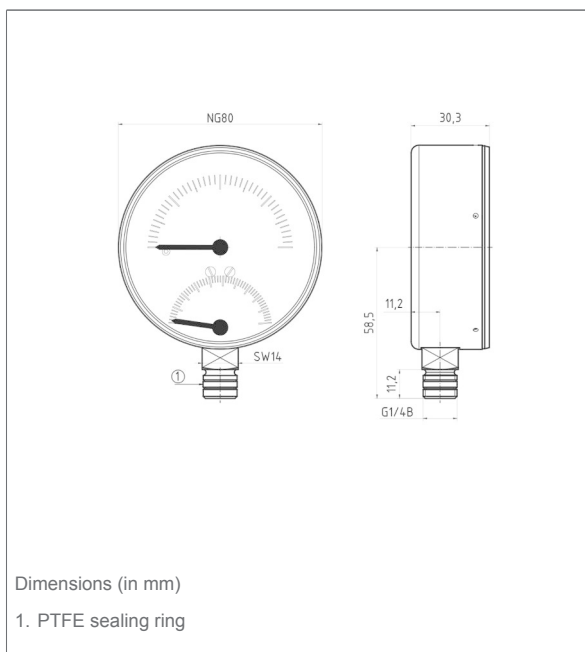

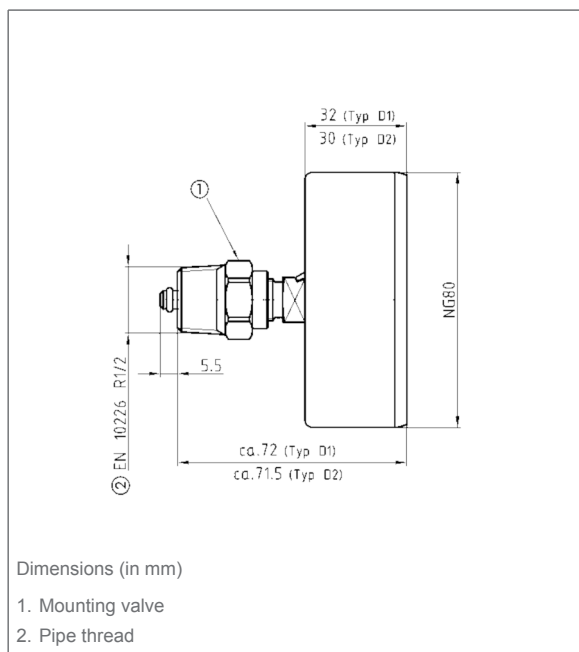

TM 80 ax with mounting valve



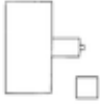

Versions

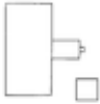
	Housing \varnothing	Housing	Mounting position	Adapter	Range		Type	Part no.
					Pressure	Temperature		
	80 mm	Plastic	Centre back		0/4 bar	20/120 °C	TM80 D111	63317
	63 mm	Sheet steel, black	Centre back	•	0/4 bar	20/120 °C	TM63 D211	63346
	63 mm	Sheet steel, black	Centre back		0/4 bar	20/120 °C	TM63 D211	63318
	80 mm	Sheet steel, black	Bottom		0/4 bar	20/120 °C	TM80 D201	63337
	80 mm	Sheet steel, black	Bottom		0/6 bar	20/120 °C	TM80 D201	63338
	80 mm	Sheet steel, black	Bottom		0/10 bar	20/120 °C	TM80 D201	63339
	80 mm	Sheet steel, black	Centre back	•	0/4 bar	20/120 °C	TM80 D211	63348
	80 mm	Sheet steel, black	Centre back		0/4 bar	20/120 °C	TM80 D211	63341
	80 mm	Sheet steel, black	Centre back		0/6 bar	20/120 °C	TM80 D211	63342
	80 mm	Sheet steel, black	Centre back		0/10 bar	20/120 °C	TM80 D211	63343

Blue part no. = in-stock items